

Installation instructions for PZ4AL-2936-00, PZ4AL-2937-00
Under Run Protective Shield Fuel Tank

TOYOTA Hilux



Hilux

Model year:

2015-

Applicability:

GUN125L-DTFSHW; GUN125L-DTFMHW
GUN126L-DTTMHW; GUN126L-DTTHHW

Part Number:

Steel: PZ4AL-2936-00
Aluminium: PZ4AL-2937-00



Weight:

Steel: 10.66 kg
Aluminium: 5.82 kg



Installation Time:

30 min

Rev.1 27.10.2015

A

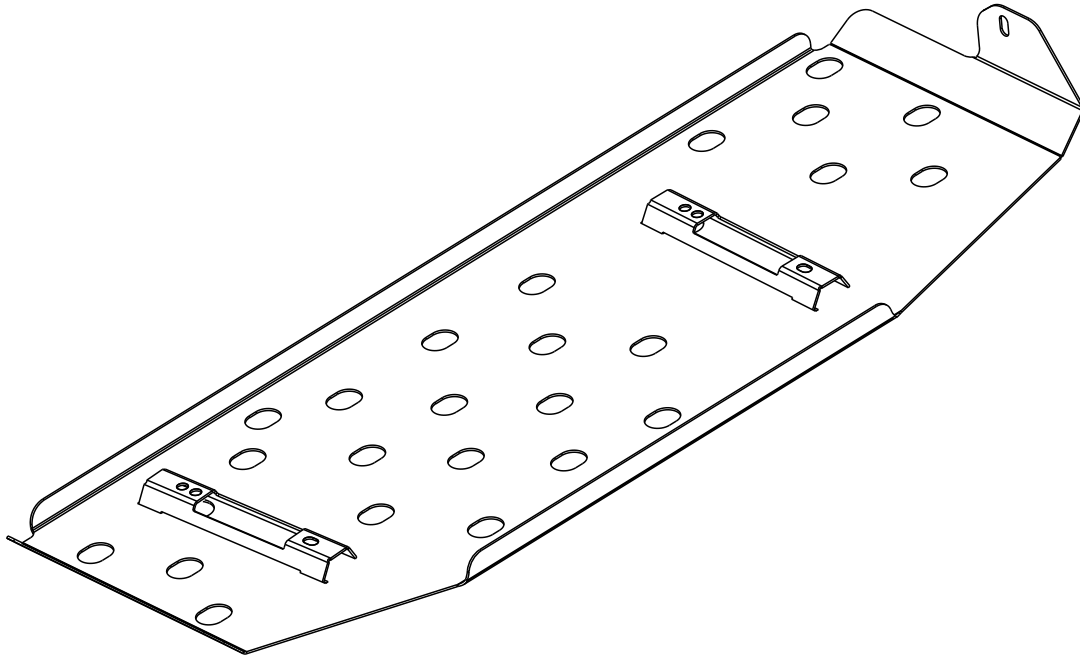

PZ4AL-02936-60

B

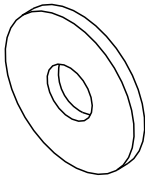

d=8

5x

C

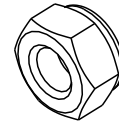

M8

5x

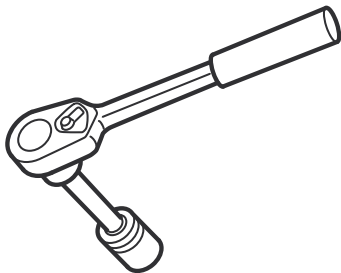

13 mm



1

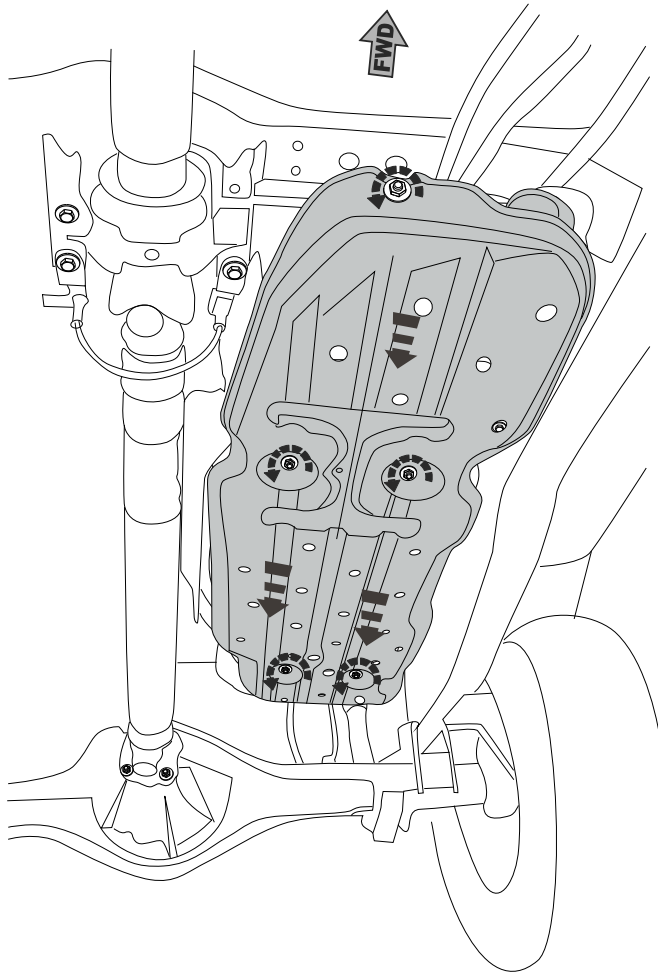
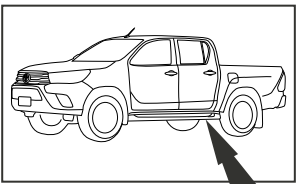

see repair manual

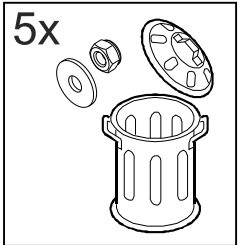
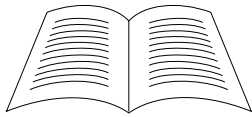

2

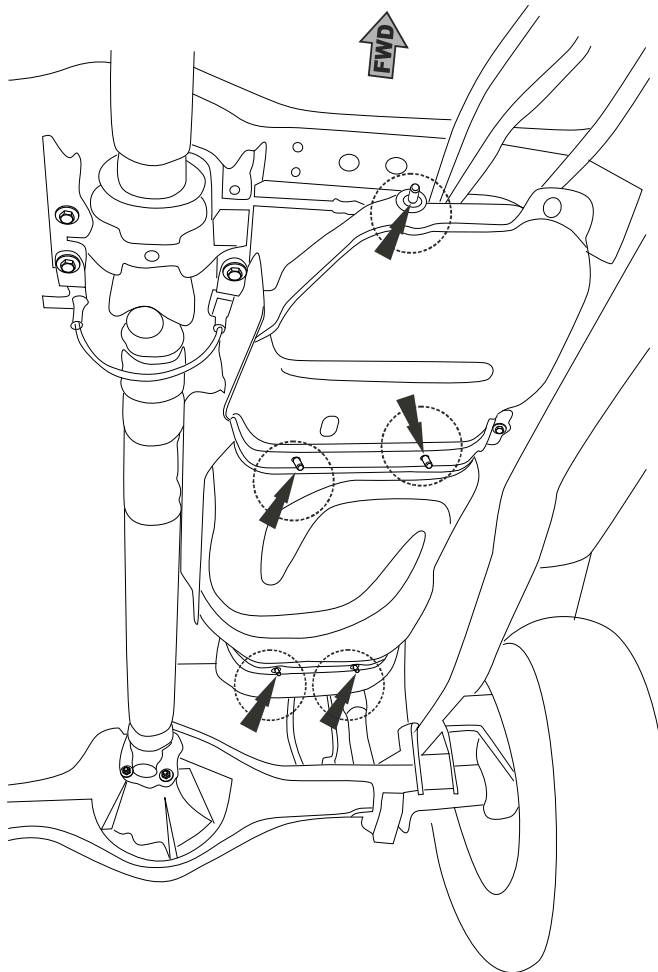
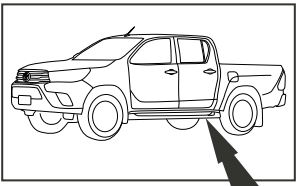

3

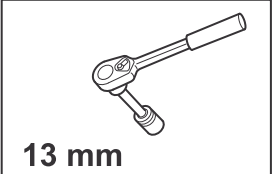
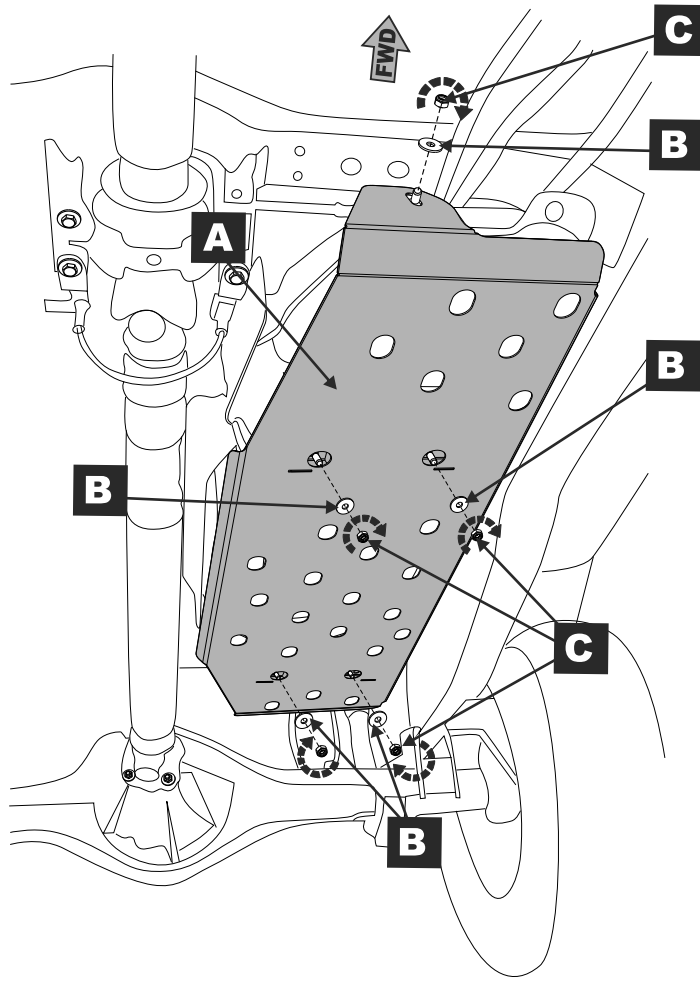
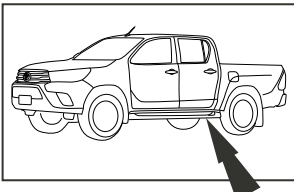

4

